



Model EX356A73

VERY HIGH TEMPERATURE, TRIAxIAL CHARGE MODE ACCELEROMETER WITH UHT-12™ ELEMENT



- Eliminates need for high temperature triaxial measurements to be taken with three separate single-axis accelerometers mounted on a triaxial mounting block.
- ATEX/CSA/IECEx intrinsic safety certification allows sensor to be used worldwide in potentially-explosive environments.
- Smaller, lighter design allows for simplified installation in even the tightest of spaces.
- Use of UHT-12™ sensing element and hermetically-sealed, nickel alloy housing provides sensor endurance in very high temperatures.

Typical Applications

- Aviation/Power Generation Turbine Research & Development
- Commissioning of Nuclear Power Plants
- Vehicle Exhaust System NVH

Provides More Consistent Sensitivity Over a Wide Temperature Range

PCB Piezotronics utilizes a UHT-12™ element that features a proprietary crystal technology sealed in a hermetic package for long-term reliability. The element has no pyroelectric output that provides accurate low-frequency measurements and reduced thermal noise spikes that eliminate false alarms during monitoring. The element also has a more consistent sensitivity over a wide temperature change to provide greater accuracy. The shear mode crystals prevent base strain and transverse measurement errors.

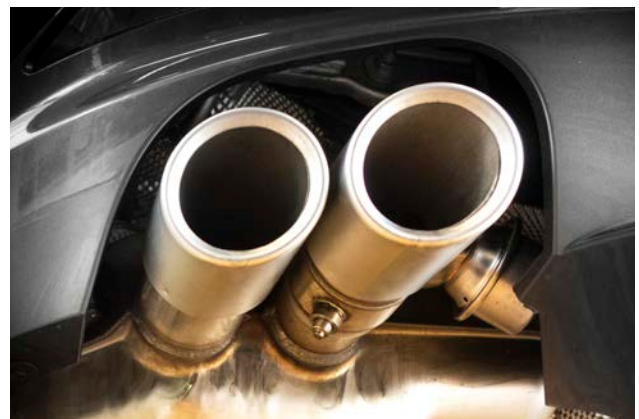







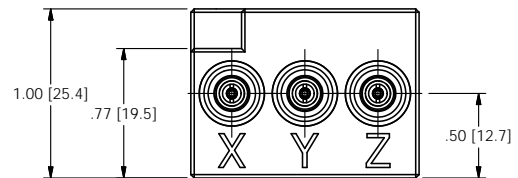
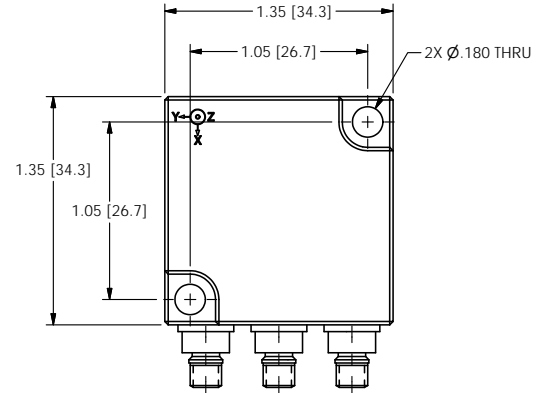

SENSORS FOR RESEARCH & DEVELOPMENT AND MACHINERY HEALTH MONITORING

Model Number	EX356A73
Performance	
Sensitivity ($\pm 5\%$)	3.2 pC/g 0.33 pC/(m/s ²)
Measurement Range	± 500 g pk $\pm 4,905$ m/s ² pk
Frequency Range ($\pm 5\%$)	Up to 4 kHz
Resonant Frequency	25 kHz
Transverse Sensitivity	$\leq 5\%$
Non-Linearity	$\leq 1\%$
Environmental	
Overload Limit (Shock)	$\pm 2,000$ g pk $\pm 19,620$ m/s ² pk
Operating Temperature Range	-67 to +900 °F -55 to +482 °C
Base Strain Sensitivity	0.003 g/ $\mu\epsilon$ 0.029 (m/s ²)/ $\mu\epsilon$
Radiation Exposure Limit (Integrated Neutron Flux)	1 E10 N/cm ²
Radiation Exposure Limit (Integrated Gamma Flux)	1 E8 rad
Electrical	
Capacitance (Pole-to-Pole)	120 pF
Insulation Resistance (Room Temp)	>1 GOhm
Insulation Resistance (900 °F / 482 °C)	>100 kOhm
Output Polarity	Negative
Electrical Isolation	Case Isolated (>1E6 Ohm)
Physical	
Sensing Geometry	Shear
Sensing Element	UHT-12™
Housing Material	Nickel Alloy
Sealing	Hermetic Welded
Mounting Thread	8-32 Male
Electrical Connector	Three 10-32 Coaxial Jacks
Electrical Connector Position	Side
Weight	5.3 oz 150 g



SENSOR CHAIN COMPONENTS		
	Non-Radiation Environment	Radiation Environment
Sensor	 EX356A73	
Hardline Cable	 023FZXXXGA	 023FZXXXFZ
Softline Cable	 003EBXXXEB	N/A
Charge Amplifier	 422E35 (1 mV/pC) 422E36 (10 mV/pC)	 422E65/A (1 mV/pC) 422E66/A (10 mV/pC)



3425 Walden Avenue, Depew, NY 14043-2495 USA

Toll-Free in the USA: 800.828.8840 | 24-hour SensorLineSM: 716.684.0001

Fax: 716.684.0987 | Email: info@pcb.com

Hochwertige Messtechnik und Beratung aus einer Hand



PCB Synotech GmbH
Porschestr. 20 – 30 ▪ 41836 Hückelhoven
Tel.: +49 (0) 24 33/44 44 40 – 0
E-Mail: info@synotech.de ▪ www.synotech.de