



**Model 394C06**

**Handheld shaker, 1g at 159.2 Hz (for up to 210 grams total weight of  
Installation and Operating Manual**

**For assistance with the operation of this product,  
contact PCB Piezotronics, Inc.**

**Toll-free: 800-828-8840  
24-hour SensorLine: 716-684-0001  
Fax: 716-684-0987  
E-mail: [info@pcb.com](mailto:info@pcb.com)  
Web: [www.pcb.com](http://www.pcb.com)**



**The information contained in this document supersedes all similar information that may be found elsewhere in this manual.**

**Total Customer Satisfaction** – PCB Piezotronics guarantees Total Customer Satisfaction. If, at any time, for any reason, you are not completely satisfied with any PCB product, PCB will repair, replace, or exchange it at no charge. You may also choose to have your purchase price refunded in lieu of the repair, replacement, or exchange of the product.

**Service** – Due to the sophisticated nature of the sensors and associated instrumentation provided by PCB Piezotronics, user servicing or repair is not recommended and, if attempted, may void the factory warranty. Routine maintenance, such as the cleaning of electrical connectors, housings, and mounting surfaces with solutions and techniques that will not harm the physical material of construction, is acceptable. Caution should be observed to insure that liquids are not permitted to migrate into devices that are not hermetically sealed. Such devices should only be wiped with a dampened cloth and never submerged or have liquids poured upon them.

**Repair** – In the event that equipment becomes damaged or ceases to operate, arrangements should be made to return the equipment to PCB Piezotronics for repair. User servicing or repair is not recommended and, if attempted, may void the factory warranty.

**Calibration** – Routine calibration of sensors and associated instrumentation is

recommended as this helps build confidence in measurement accuracy and acquired data. Equipment calibration cycles are typically established by the users own quality regimen. When in doubt about a calibration cycle, a good “rule of thumb” is to recalibrate on an annual basis. It is also good practice to recalibrate after exposure to any severe temperature extreme, shock, load, or other environmental influence, or prior to any critical test.

PCB Piezotronics maintains an ISO-9001 certified metrology laboratory and offers calibration services, which are accredited by A2LA to ISO/IEC 17025, with full traceability to N.I.S.T. In addition to the normally supplied calibration, special testing is also available, such as: sensitivity at elevated or cryogenic temperatures, phase response, extended high or low frequency response, extended range, leak testing, hydrostatic pressure testing, and others. For information on standard recalibration services or special testing, contact your local PCB Piezotronics distributor, sales representative, or factory customer service representative.

**Returning Equipment** – *Following these procedures will insure that your returned materials are handled in the most expedient manner.* Before returning any equipment to PCB Piezotronics, contact your local distributor, sales representative, or factory customer service representative to obtain a Return

Materials Authorization (RMA) Number. This RMA number should be clearly marked on the outside of all package(s) and on the packing list(s) accompanying the shipment. A detailed account of the nature of the problem(s) being experienced with the equipment should also be included inside the package(s) containing any returned materials.

A Purchase Order, included with the returned materials, will expedite the turn-around of serviced equipment. It is recommended to include authorization on the Purchase Order for PCB to proceed with any repairs, as long as they do not exceed 50% of the replacement cost of the returned item(s). PCB will provide a price quotation or replacement recommendation for any item whose repair costs would exceed 50% of replacement cost, or any item that is not economically feasible to repair. For routine calibration services, the Purchase Order should include authorization to proceed and return at current pricing, which can be obtained from a factory customer service representative.

**Warranty** – All equipment and repair services provided by PCB Piezotronics, Inc. are covered by a limited warranty against defective material and workmanship for a period of one year from date of original purchase. Contact

PCB for a complete statement of our warranty. Expendable items, such as batteries and mounting hardware, are not covered by warranty. Mechanical damage to equipment due to improper use is not covered by warranty. Electronic circuitry failure caused by the introduction of unregulated or improper excitation power or electrostatic discharge is not covered by warranty.

**Contact Information** – International customers should direct all inquiries to their local distributor or sales office. A complete list of distributors and offices can be found at [www.pcb.com](http://www.pcb.com). Customers within the United States may contact their local sales representative or a factory customer service representative. A complete list of sales representatives can be found at [www.pcb.com](http://www.pcb.com). Toll-free telephone numbers for a factory customer service representative, in the division responsible for this product, can be found on the title page at the front of this manual. Our ship to address and general contact numbers are:

PCB Piezotronics, Inc.  
3425 Walden Ave.  
Depew, NY 14043 USA  
Toll-free: (800) 828-8840  
24-hour SensorLine<sup>SM</sup>: (716) 684-0001  
Website: [www.pcb.com](http://www.pcb.com)  
E-mail: [info@pcb.com](mailto:info@pcb.com)

## 1.0 INTRODUCTION

The Model 394C06 Handheld Shaker is a small, handy, completely self-contained vibration reference source. It is intended for rapid checking of vibration measurement, monitoring, and recording systems using piezoelectric accelerometers, as well as other types of vibration transducers having a maximum mass of 210 grams. See Figure 1.

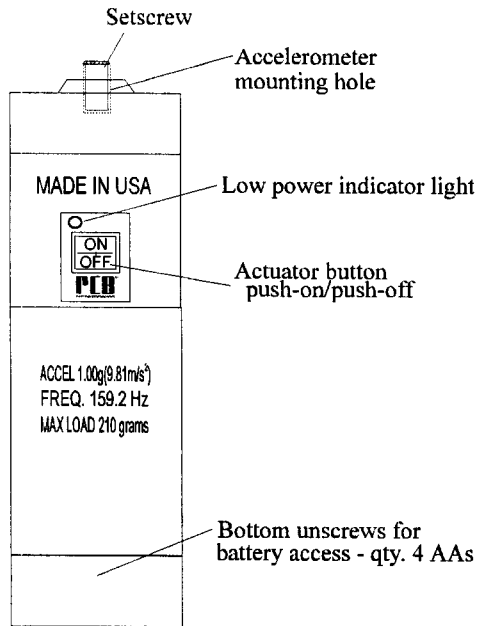

Figure 1. Model 394B06 Handheld Calibrator

## 2.0 DESCRIPTION

The Model 394C06 permits accurate adjustment of measuring instrumentation to indicate a standard acceleration level of 1g RMS or 1 g peak, adjusting the system for correct measurement. The reference signal may also be used for velocity and displacement, at 10  $\text{mms}^{-1}$  RMS or 10  $\text{mms}^{-1}$  peak and 10  $\mu\text{m}$  RMS or 10  $\mu\text{m}$  peak-to-peak, respectively. To change between RMS and peak, depress the corresponding side of the rocker switch in the options cavity of the shaker. For example, to choose RMS, depress the left side of the rocker switch (see Figure 4).

A system adjustment using the Model 394C06 also provides a quick check of the correct function of the complete measurement system.

A sectional view of the shaker's vibration head is shown in Figure 2. The shaker consists of an electromagnetic exciter, driven by an oscillator at a frequency of 159.2 Hz ( $1000 \text{ rads}^{-1}$ ). A small ICP<sup>®</sup> accelerometer provides a servo feedback to maintain a constant vibration level of 1 g. This enables accelerometers with masses of up to 210 grams to be adjusted without their mass influencing the reference level.

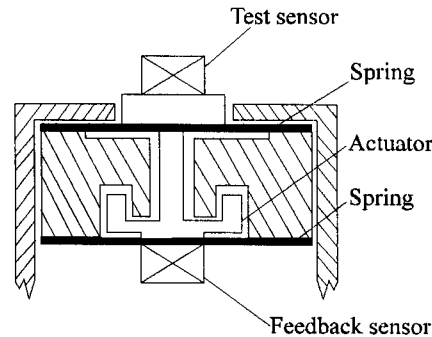

Figure 2. Shaker's Vibration Head: Cross-Section

Use of the shaker is straight-forward. The accelerometer is attached to the shaker using the supplied 10-32 BeCu stud. Alternatively, the supplied mounting base, Model 080A84, provides a means of attaching accelerometers having a 5-44 stud or integral stud. Model 080A150 Threaded Mounting Pad allows accelerometer attachment with a 1/4-28 capscrew.

A flat mounting plate is also supplied for mounting accelerometers with Petro Wax or other adhesives. Connect the accelerometer to the vibration level indicating instrument and activate the shaker by pushing the ON/OFF button on the side of the shaker. See Figure 1.

The indicating instrument may now be adjusted to read the relevant reference value. Following the system adjustment, the shaker is switched off by pressing the ON/OFF button a second time. To prolong the useful

<sup>®</sup> ICP is a registered trademark of PCB Piezotronics, Inc., which uniquely identifies PCB's sensors incorporating built-in electronics.

life of the batteries, the Model 394A06 automatically switches off after 90 seconds. With new batteries, 80 sensitivity checks with maximum load are possible. To change between auto shutoff and continuous run, depress the corresponding side of the rocker switch in the options cavity of the shaker. For example to choose auto shutoff, depress the left side of the rocker switch (see Figure 4).

### 3.0 OPERATION

When the ON/OFF button is pushed the first time, the Model 394C06 Handheld Shaker is activated. Power is ramped up to the actuator to provide a smooth, gradual turn-on. This action prevents shock-induced overloads to the test sensor. A special sensor within the unit constantly measures the g level and adjusts to maintain 1 g. The frequency is 159.2 Hz. Since a relatively stiff suspension is used, any sensor up to 210 grams can be verified without affecting accuracy. Model 394C06 is powered by four (4) "AA" batteries in a pack, Model 073A15. Alkaline batteries are recommended for a longer service life. Since the Model 394C06 is a precision instrument and is used to check the sensitivity of sensors, it should be verified prior to use with a reference standard. The unit has several unique features of interest:

- **Continuous use option switch.** In this mode, once the shaker is turned on, it does not shut off until the ON/OFF button is depressed a second time. The default position of this switch is AUTO; the unit turns off automatically after a preset time.
- **Peak / RMS selection.** If a 100 mV/g sensor is on the shaker table, and the unit is in peak mode, then the output is 100 mV. If the switch is set to RMS, then the output is 141 mV. See Figure 3.

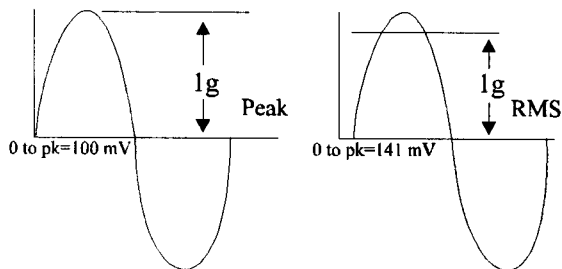

Figure 3. Peak vs. RMS Selection with 100 mV/g Accelerometer

- **External power supply.** An optional Model 073A16 DC power supply is available for powering the Model 394C06 Shaker. It operates off of 85 to 265 VAC, 47 to 63 Hz input. When this power supply is plugged into the shaker, the internal batteries are automatically disconnected.
- **Calibration check points.** Calibration of the internal feedback circuit can be verified via test points (located in the options access pocket). See Figure 4.

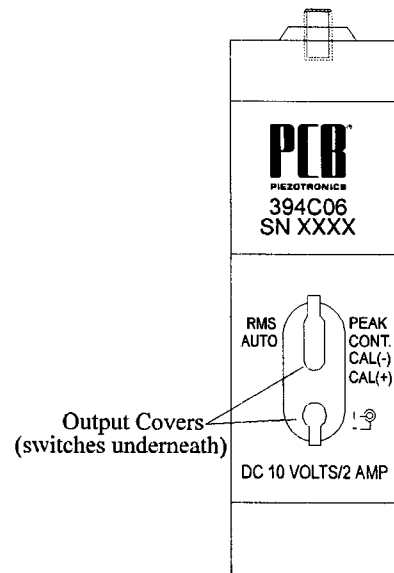

Figure 4. Handheld Shaker Calibration Check Points

The measured value in volts should agree with the calibration certificate. This is useful for a quick field check of unit integrity, such as that which might be needed if the shaker is dropped and a reference standard is not immediately available. This test is not a guarantee of shaker function. If the data does not agree with expected values, the shaker should be checked with a calibration standard before continued use.

- **Low power indicator.** A low power indicator light is located above the ON/OFF switch. See Figure 1. This light glows when the available power is marginally adequate to drive the shaker (with the mass on the shaker). This indicator does not signify erroneous data. If the Model 394C06 cannot obtain 1 g at 159.2 Hz, then the unit shuts off. The low power indicator signifies an imminent inability to drive the mass on the shaker. The test sensor is too

heavy, the batteries are low on power, or the external power supply is inadequate.

#### 4.0 MAINTENANCE AND REPAIR

This unit is fully CE compliant. Aside from battery replacement, no maintenance is required for this unit. It is suggested that if trouble occurs, contact the factory for assistance. Because of the nature of PCB instrumentation, field repair is typically not recommended and voids the warranty. If factory service is required, return the instrument to PCB. A free quotation will be provided prior to servicing.

To expedite the repair process, contact a PCB Customer Service Representative for a Return Materials Authorization (RMA) number prior to sending equipment to the factory. Please have pertinent information available, such as model and serial numbers. Also, to insure efficient service, be sure to include a brief written description of the problem. International customers should return equipment to a local distributor, or contact PCB if no distributors are available.

PCB Piezotronics, Inc. is an ISO 9001 certified company that has embraced its company mission of TOTAL CUSTOMER SATISFACTION. This is a guarantee that means if at any time you are not satisfied with any of our products or service, we will correct the problem. Please contact us for high-quality equipment and unmatched customer support. If you have any questions or concerns on the use of any PCB product or the aforementioned policies, call the PCB Vibration Group at 716-684-0001.

MANUAL NUMBER: 18295  
MANUAL REVISION: NR

	<u>ENGLISH</u>	<u>SI</u>	
<b>Performance</b>			
Operating Frequency(± 1 %)	159.2 Hz	159.2 Hz	
Acceleration Output(± 3 %)	1.00 g rms	9.81 m/s <sup>2</sup> rms	[6]
Velocity Output	0.39 in/sec rms	9.81 mm/s rms	[7]
Displacement Output	0.39 mil rms	9.81 μm rms	[7]
Transverse Output	≤ 3 %	≤ 3 %	
Distortion(0 to 99 grams load)	≤ 2 %	≤ 2 %	
Distortion(100 to 149 grams load)	≤ 5 %	≤ 5 %	
Distortion(150 to 210 grams load)	≤ 9 %	≤ 9 %	
Maximum Load	7.4 oz	210 gm	[8]
Automatic Switch Off Time	1.0 to 2.5 minutes	1.0 to 2.5 minutes	[9]
Calibration Cycles(2 gram load)	320 cycles	320 cycles	[5]
Calibration Cycles(25 gram load)	600 cycles	600 cycles	[5]
Calibration Cycles(50 gram load)	1600 cycles	1600 cycles	[5]
Calibration Cycles(100 gram load)	400 cycles	400 cycles	[5]
Calibration Cycles(150 gram load)	160 cycles	160 cycles	[5]
Calibration Cycles(210 gram load)	80 cycles	80 cycles	[5]
<b>Environmental</b>			
Temperature Range(Operating)	+15 to +130 °F	-10 to +55 °C	
<b>Electrical</b>			
Ramp-Up time	≤ 3 sec	≤ 3 sec	[1]
Internal Battery(Quantity)	4	4	
Internal Battery(Type)	AA	AA	[2]
DC Power	10 VDC	10 VDC	[3]
DC Power	2.4 amps	2.4 amps	[4][3]
Battery Life(2 gram load)	8 hours	8 hours	[5]
Battery Life(25 gram load)	15 hours	15 hours	[5]
Battery Life(50 gram load)	40 hours	40 hours	[5]
Battery Life(100 gram load)	10 hours	10 hours	[5]
Battery Life(150 gram load)	4 hours	4 hours	[5]
Battery Life(210 gram load)	2 hours	2 hours	[5]
<b>Physical</b>			
Size (Diameter x Height)	2.2 in x 7.8 in	56 mm x 200 mm	
Weight(with batteries)	31 oz	900 gm	[1]
Mounting Thread	10-32 Female	10-32 Female	[10][11]
Mounting Torque(Maximum)	10 in-lb	112 N-cm	[11]

**OPTIONAL VERSIONS**

Optional versions have identical specifications and accessories as listed for the standard model except where noted below. More than one option may be used.

**M - Metric Mount**

Acceleration Output(± 3 %)	1.02 g rms	10.0 m/s <sup>2</sup> rms
----------------------------	------------	---------------------------

- NOTES:**
- [1] Typical.
  - [2] Alkaline type recommended for longest service life.
  - [3] This specification for external DC power supply (optional).
  - [4] Maximum.
  - [5] Approximate values, based on automatic switch off time and dependent on type of batteries.
  - [6] Unit supplied set to rms; see manual for peak selection.
  - [7] Calculated values for reference only.
  - [8] Maximum load includes sensor, connector and cabling.
  - [9] Unit supplied set to auto shut off; see manual for continuous use selection.
  - [10] Test sensor should be hand tightened (without tools).
  - [11] Transducer to shaker table.
  - [12] See PCB Declaration of Conformance PS022 for details.

- SUPPLIED ACCESSORIES:**
- Model 073A15 Battery Pack (1)
  - Model 080A109 Petro Wax (1)
  - Model 080A84 Mounting Base (5-40 to 10-32) (1)
  - Model 080A85 Mounting Base (M3 X 0.5 to 10-32) (1)
  - Model 081A08 Mounting Stud (10-32 to 1/4-28) (1)
  - Model 081B05 Mounting Stud (10-32 to 10-32) (2)
  - Model M081B05 Mounting Stud 10-32 to M6 X 0.75 (1)
  - Model M081B23 Metric mounting stud, 10-32 to M5 x 0.80 long (1)
- OPTIONAL ACCESSORIES:**
- Model 073A16 DC switching power supply (for Model 394C06) (1)
  - Model 080A150 Mounting Base (1/4-28) (1)
  - Model 080B44 3-Pin Mounting Adapter (1)

Entered: AP	Engineer: AJP	Sales: WDC	Approved: JWH	Spec Number:
Date: 1/28/2013	Date: 1/28/2013	Date: 1/28/2013	Date: 1/28/2013	<b>1345</b>



All specifications are at room temperature unless otherwise specified.  
 In the interest of constant product improvement, we reserve the right to change specifications without notice.  
 ICP® is a registered trademark of PCB Group, Inc.



**Phone: 716-684-0001**  
**Fax: 716-684-0987**  
**E-Mail: info@pcb.com**





081-XXXX-90

PCB Piezotronics Inc. claims proprietary rights in the information disclosed hereon. Neither it nor any reproduction thereof will be disclosed to others without the written consent of PCB Piezotronics Inc.

**STANDARD STUD MOUNT**

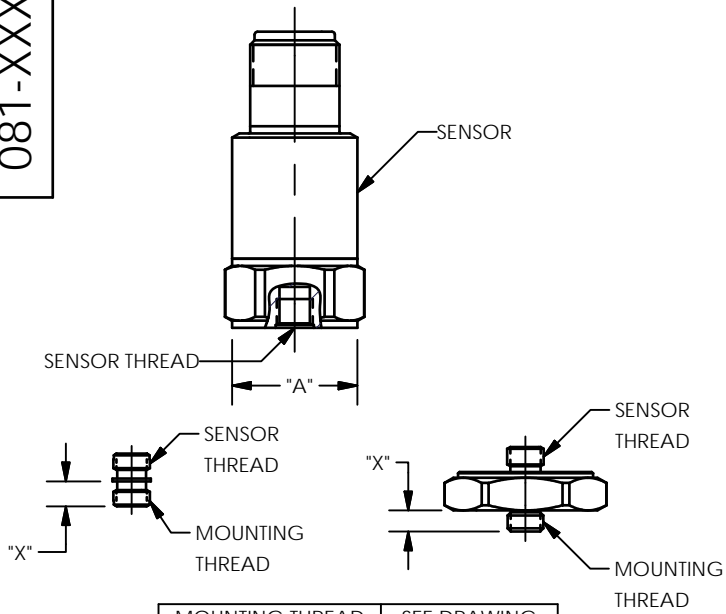

MOUNTING THREAD	SEE DRAWING
5-40	A
M3 X 0.50	B
10-32	C
M5 X 0.80	D
1/4-28	E
M6 X 1.00	F

**"A"**  
5-40  
**MOUNTING INSTRUCTIONS**  
(METRIC DIMENSIONS IN BRACKETS)

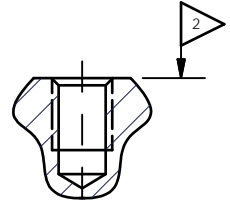

**MOUNTING HOLE PREPARATION:**  
 1)  $\phi .101[\phi 2.57]$   
 X .20[5.1]  $\nabla$  MIN.  
 5-40 UNC-2B  
 X .15[3.8]  $\nabla$  MIN.

4.) RECOMMENDED MOUNTING TORQUE,  
 4-5 INCH POUNDS  
 [45-55 NEWTON CENTIMETERS].

**"B"**  
M3 X 0.50  
**MOUNTING INSTRUCTIONS**  
(ENGLISH DIMENSIONS IN BRACKETS)

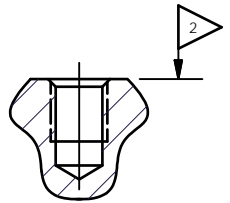

**MOUNTING HOLE PREPARATION:**  
 1)  $\phi 2.5[\phi .099]$   
 X 4.6 [1.8]  $\nabla$  MIN.  
 M3 X 0.50-6H  
 X 3.3[.13]  $\nabla$  MIN.

4.) RECOMMENDED MOUNTING TORQUE,  
 45-55 NEWTON CENTIMETERS  
 [4-5 INCH POUNDS].

**"C"**  
10-32  
**MOUNTING INSTRUCTIONS**  
(METRIC DIMENSIONS IN BRACKETS)

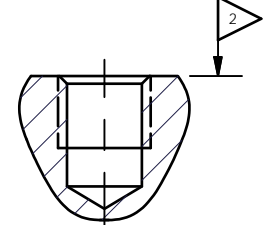

**MOUNTING HOLE PREPARATION:**  
 1)  $\phi .159[\phi 4.04]$   
 X .23[5.8]  $\nabla$  MIN.  
 10-32 UNF-2B  
 X .15[3.8]  $\nabla$  MIN.

4.) RECOMMENDED MOUNTING TORQUE,  
 10-20 INCH POUNDS  
 [113-225 NEWTON CENTIMETERS].

**"D"**  
M5 X 0.80  
**MOUNTING INSTRUCTIONS**  
(ENGLISH DIMENSIONS IN BRACKETS)

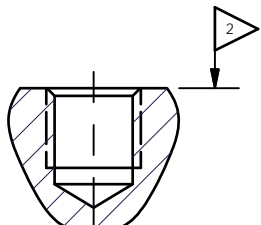

**MOUNTING HOLE PREPARATION:**  
 1)  $\phi 4.22[\phi .166]$   
 X 7.62 [.300]  $\nabla$  MIN.  
 M5 X 0.8-6H  
 X 5.08[.200]  $\nabla$  MIN.

4.) RECOMMENDED MOUNTING TORQUE,  
 113-225 NEWTON CENTIMETERS  
 [10-20 INCH POUNDS].

REVISIONS		
REV	DESCRIPTION	DIN
P	UPDATE DRAWING	25686

**INTEGRAL STUD MOUNT**

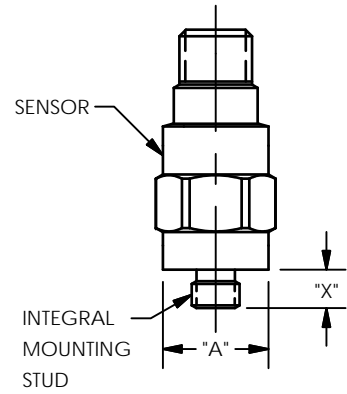

MOUNTING THREAD	SEE DRAWING
5-40	A
M3 X 0.50	B
10-32	C
M5 X 0.80	D
1/4-28	E
M6 X 1.00	F

**"THRU-BOLT" STUD MOUNT**

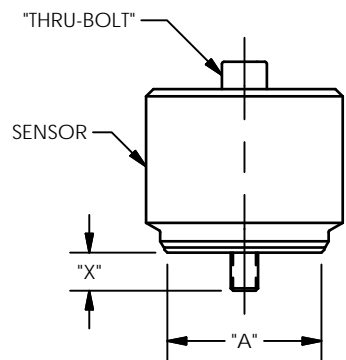

BOLT THREAD	SEE DRAWING
10-32	C
M5 X 0.80	D
1/4-28	E
M6 X 1.00	F
M8 X 1.25	F

**"E"**  
1/4-28  
**MOUNTING INSTRUCTIONS**  
(METRIC DIMENSIONS IN BRACKETS)

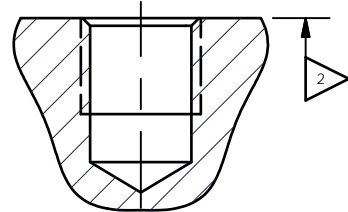

**MOUNTING HOLE PREPARATION:**  
 1)  $\phi .218[\phi 5.54]$   
 X .300[7.62]  $\nabla$  MIN.  
 1/4-28 UNF-2B  
 X .200[5.08]  $\nabla$  MIN.

4.) RECOMMENDED MOUNTING TORQUE,  
 2-5 FOOT POUNDS  
 [3-7 NEWTON METERS].

**"F"**  
M6 X 0.75, M6 X 1.00, M8 X 1.25  
**MOUNTING INSTRUCTIONS**  
(ENGLISH DIMENSIONS IN BRACKETS)

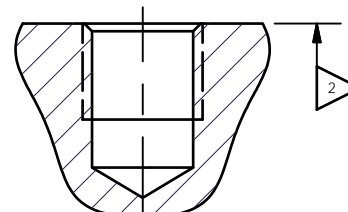

**M6 X 0.75 MOUNTING HOLE PREPARATION:**  
 1)  $\phi 5.31[\phi .209]$   
 X 7.62 [.300]  $\nabla$  MIN.  
 M6 X 0.75-6H  
 X 5.08[.200]  $\nabla$  MIN.

**M6 X 1.0 MOUNTING HOLE PREPARATION:**  
 1)  $\phi 5.05[\phi .199]$   
 X 8.10 [.320]  $\nabla$  MIN.  
 M6X 1.0-6H  
 X 6.35[.250]  $\nabla$  MIN.

4.) RECOMMENDED MOUNTING TORQUE,  
 3-7 NEWTON METERS [2-5 FT POUNDS].

**M6 X 0.75 MOUNTING HOLE PREPARATION:**  
 1)  $\phi 5.31[\phi .209]$   
 X 7.62 [.300]  $\nabla$  MIN.  
 M6 X 0.75-6H  
 X 5.08[.200]  $\nabla$  MIN.

**M8 X 1.25 MOUNTING HOLE PREPARATION:**  
 1)  $\phi 6.75[\phi .266]$   
 X 8.64 [.340]  $\nabla$  MIN.  
 M8 X 1.25-6H  
 X 5.00[.197]  $\nabla$  MIN.

**"G"**  
**MOUNTING INSTRUCTIONS**  
FOR SPECIAL THREAD LENGTHS  
(METRIC DIMENSIONS IN BRACKETS)

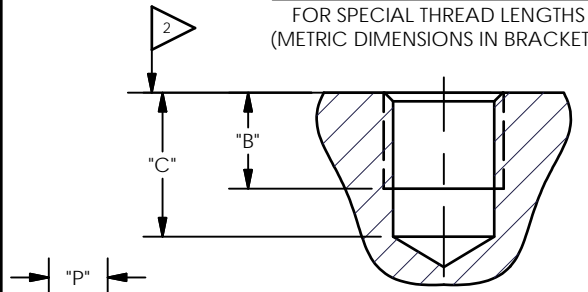

**MOUNTING HOLE PREPARATION:**  
 1)  $\phi$  DRILL DIA.  
 X "C"  $\nabla$  MIN.  
 TAP  
 X "B"  $\nabla$  MIN.

1 THREAD PITCH SHOWN

THREAD DEPTH : B = X + 1 THREAD PITCH  
 DRILL DEPTH : C = B + 3 THREAD PITCH  
 SEE A-F FOR APPROPRIATE DRILL AND TAP  
 THREAD PITCH = 1/TPI [P]

- 3.) FOR BEST RESULTS, PLACE A THIN LAYER OF SILICONE GREASE (OR EQUIVALENT) ON INTERFACE PRIOR TO MOUNTING.
- 2) MOUNTING SURFACE SHOULD BE FLAT TO WITHIN .001(0.03) TIR OVER DIM 'A' WITH A  $\frac{63[1.61]}{\sqrt{\quad}}$  OR BETTER FINISH FOR BEST RESULTS.
- 1) DRILL PERPENDICULAR TO MOUNTING SURFACE TO WITHIN  $\pm 1^\circ$ .

UNLESS OTHERWISE SPECIFIED TOLERANCES ARE:

DIMENSIONS IN INCHES	DIMENSIONS IN MILLIMETERS [IN BRACKETS]
DECIMALS XX $\pm .01$ XXX $\pm .005$	DECIMALS X $\pm 0.3$ XX $\pm 0.13$
ANGLES $\pm 2$ DEGREES	ANGLES $\pm 2$ DEGREES
FILLETS AND RADII .003 - .005	FILLETS AND RADII 0.07 - 0.13

DRAWN		CHECKED		ENGINEER	
JDM	3/9/07	ECB	3/9/07	JJD	3/9/07

TITLE  
 INSTALLATION DRAWING  
 FOR STANDARD  
 081 SERIES MOUNTING



3425 WALDEN AVE. DEPEW, NY 14043  
 (716) 684-0001 E-MAIL: sales@pcb.com

CODE IDENT. NO. 52681	DWG. NO. 081-XXXX-90
SCALE: N.T.S.	SHEET 1 OF 1